

# 2PSS60A40

## Solid State Relays

### 3-Phase with Integrated Heatsink



- 2-pole AC switching solid state contactors
- Product width 2.84" (72 mm)
- Rated operational voltage: 600 VAC
- Rated operational current: up to 40 AAC
- Control voltages: 20-275 VAC (24-190 VDC)
- 6,600 A<sup>2</sup>s for I<sup>2</sup>t
- Motor ratings up to 11 kW / 15 HP @ 600 VAC
- Integrated varistor protection on output
- UL, cUL Listing
- 100 kA Short Circuit Current Rating according to UL 508
- DIN or panel mount
- RoHS compliant

## Product Description

This product is intended to replace mechanical contactors especially when switching is frequent.

Switch ON occurs at the voltage zero cross and switch OFF occurs at the current zero cross. Apart from resistive and slightly inductive loads, the 2PSS60A40 is certified for motor switching with associated motor ratings. Varistors are integrated for output overvoltage protection. A green LED gives indication of control voltage presence.

Specifications are at a surrounding temperature of 25°C unless otherwise specified.

## General Specifications

		2PSS60A40
Latching voltage (across each pole L-T)		<20V
Operational frequency range		45 to 65Hz
Power factor		>0.5 at rated voltage
CE marking		Yes
Touch protection		IP20
LED status indication		
	Control ON	Green, full intensity
Pollution degree		2 (non-conductive pollution with possibilities of condensation)
Over-voltage category		III (fixed installations)
Isolation		
	Input & Output to Case	4000 Vrms
	Input to Output	4000 Vrms

## Output Voltage Specifications

		2PSS60A40
Operational voltage range, Ue		42-600 VAC -15% / +10% on max
Blocking voltage		1200 Vp
Internal varistors (across each pole)		625 V



## Output Specifications: 2PSS

	2PSS60A40
Rated operational current per pole <sup>7</sup> AC-51 @ Ta=25°C AC-51 @ Ta=40°C AC-53a @ Ta=40°C	50 AAC 40 AAC 16.5 AAC
No. of motor starts <sup>8</sup> (x: 6, Tx: 6s, F: 50%) @ 40°C	30
Minimum operational current	400 mA
Rep. overload current (Motor rating) UL 508: Ta=40°C, t <sub>ON</sub> =1s, t <sub>OFF</sub> =9s, 50 cycles	107 AAC
Maximum transient surge current (I <sub>TSM</sub> ), t=10ms	1150 Ap
I <sup>2</sup> t for fusing (t=10ms) Minimum	6600 A <sup>2</sup> s
Critical dv/dt (@ Tj init = 40°C)	1000 V/us

7: Refer to Derating Curves  
8: Overload cycle definition, x: multiple of AC-53a, Tx: duration of current surge, F: duty cycle

## Motor Ratings: HP (UL 508) / kW (EN/IEC 60947-4-2) @ 40°C

	115 VAC	230 VAC	400 VAC	480 VAC	600 VAC
2PSS60A40	3 HP / 1.5 kW	5 HP / 4.0 kW	10 HP / 7.5 kW	10 HP / 9.0 kW	15 HP / 11.0 kW

## Control Specifications (A1, A2)

	2PSS60A40
Control voltage range, U <sub>c</sub>	20-275 VAC, 24 (-10%) -190 VDC
Pick-up voltage	20 VAC/DC
Drop-out voltage	5 VAC/DC
Maximum reverse voltage	-
Maximum response time	2 cycles @ 230 VAC / 110 VDC
Input current @ 40°C	See diagrams below

## Output Power Dissipation

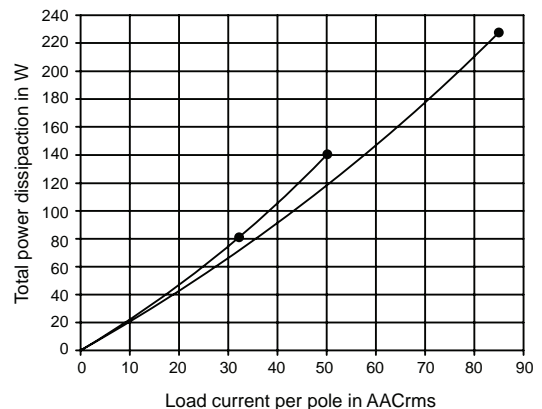
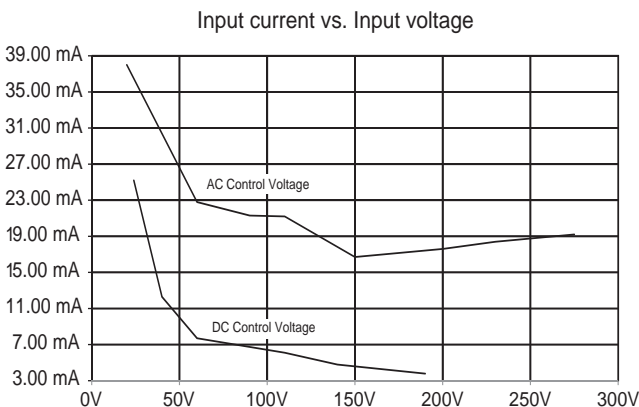

## Current Derating

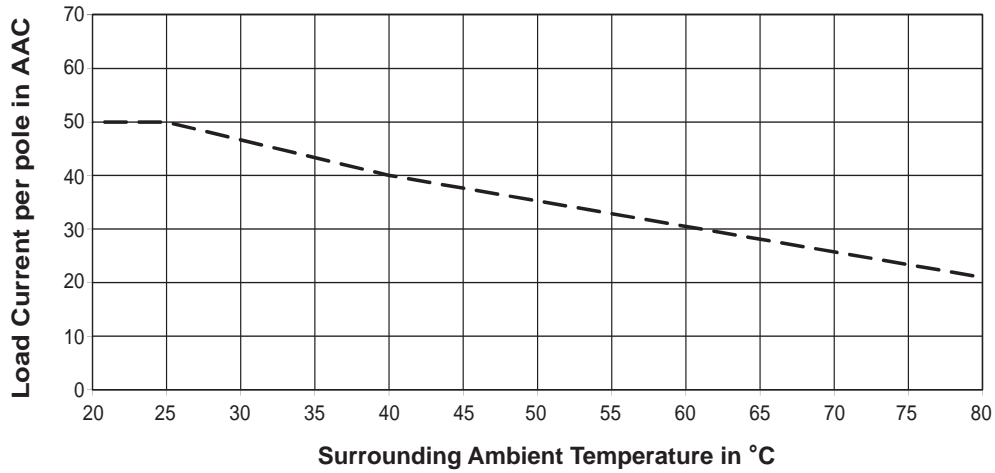

## Filtering - EN/IEC 55011 Class A Compliance

Part Number	Suggested filter for compliance	Maximum heater current
2PSS60A40	330 nF / 760V / X1	40 AAC

## Filter Connection Diagrams

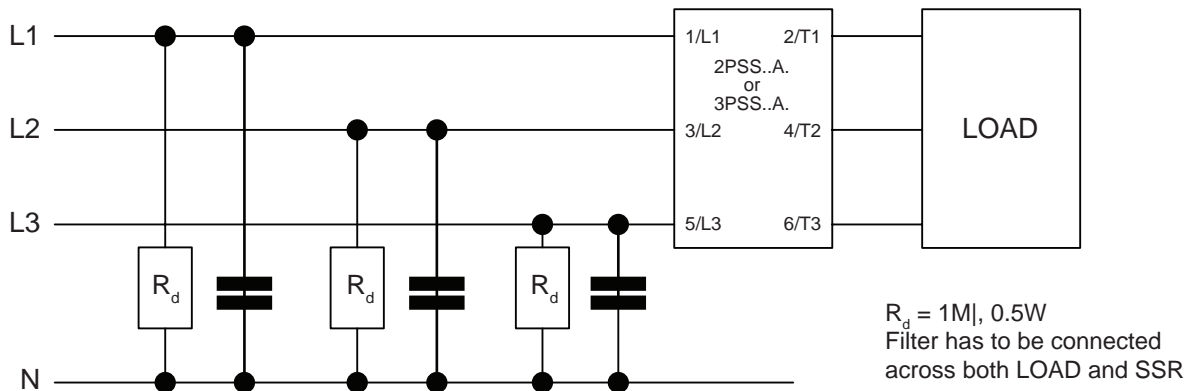



## Agency Approvals and Conformance

Conformance

EN/IEC 60947-4-2  
EN/IEC 60947-4-3

Agency Approvals

UL listed (E172877), UL508  
cUL Listed (E172877),  
C22.2 No.14-10



Short Circuit Current rating

100kArms, UL508

## Electromagnetic Compatibility

<b>EMC immunity</b>	EN/IEC 60947-4-2	<b>Radiated radio frequency immunity</b>	EN/IEC 61000-4-3
<b>Electrostatic discharge (ESD) immunity</b> Air discharge, 8 kV Contact, 4 kV	EN/IEC 61000-4-2 Performance Criteria 2 Performance Criteria 2	10 V/m, 80 - 1000 MHz 10 V/m, 1.4 - 2.0 GHz 10 V/m, 2.0 - 2.7 GHz	Performance Criteria 1 Performance Criteria 1 Performance Criteria 1
<b>Electrical fast transient (Burst) immunity</b> Output: 2 kV, 5 kHz Input: 1 kV, 5 kHz Signal: 1 kV, 5 kHz .PSS...-..M	EN/IEC 61000-4-4 Performance Criteria 1 Performance Criteria 1 Performance Criteria 1	<b>Conducted radio frequency immunity</b> 10 V/m, 0.15 - 80 MHz	EN/IEC 61000-4-6 Performance Criteria 1
<b>Electrical surge immunity</b> Output, line to line, 1 kV Output, line to earth, 2 kV Input, line to earth, 1 kV (A1, A2)	EN/IEC 61000-4-5 Performance Criteria 1 Performance Criteria 1 Performance Criteria 2	<b>Voltage dips immunity</b> 0% for 0.5 / 1cycle 40% for 10 cycles 70% for 250 cycles	EN/IEC 61000-4-11 Performance Criteria 2 Performance Criteria 2 Performance Criteria 2
<b>EMC emission</b>	EN/IEC 61000-6-4	<b>Voltage interruptions immunity</b> 0% for 5000 ms	EN/IEC 61000-4-11 Performance Criteria 2
<b>Radio interference voltage emission (conducted)</b> 0.15-30 MHz	EN/IEC 55011 Class A (Industrial) with filters - see filter information	<b>Radio interference field emission (radiated)</b> 30-1000 MHz	EN/IEC 55011 Class A (Industrial)

Note:

- Control input lines must be installed together to maintain products susceptibility to Radio Frequency Interference.
- Use of AC solid state relays may according to the application and the load current, cause conducted radio interferences. Use of mains filters may be necessary for cases where the user must meet E.M.C requirements. The capacitor values given inside the filtering specification tables should be taken only as indications, the filter attenuation will depend on the final application.
- This product has been designed for Class A equipment. Use of this product in domestic environments may cause radio interference, in which case the user may be required to employ additional mitigation methods.
- Surge tests on 2PSS60A40 models were carried out with the signal line impedance network. In case the line impedance is less than 40Ω, it is suggested that AC supply is provided through a secondary circuit where the short circuit limit between conductors and ground is 1500VA or less.

- Performance Criteria 1 (Performance Criteria A): No degradation of performance or loss of function is allowed when the product is operated as intended.
- Performance Criteria 2 (Performance Criteria B): During the test, degradation of performance or partial loss of function is allowed. However, when the test is complete the product should return operating as intended by itself.
- Performance Criteria 3 (Performance Criteria C): Temporary loss of function is allowed, provided the function can be restored by manual operation of the control.

## Environmental Specifications

<b>Operating temperature</b>	-40°C to +80°C (-40°F to +176°F)	<b>Vibration resistance</b>	
<b>Storage temperature</b>	-40°C to +100°C (-40°F to +212°F)	(2-100Hz, IEC60068-2-26, EN50155, EN61373)	2g per axis
<b>Impact resistance</b> (EN50155, EN61373)	15/11 g/ms	<b>Relative humidity</b>	95% non condensing @ 40°C

## Environmental Specifications (continued)

UL flammability rating (for plastic)	UL 94 V0	Installation altitude	0 - 1000m. Above 1000m derate linearly by 1% of FLC per 100m up to maximum of 2000m
Weight	Approx. 850g		

## Terminal Layout

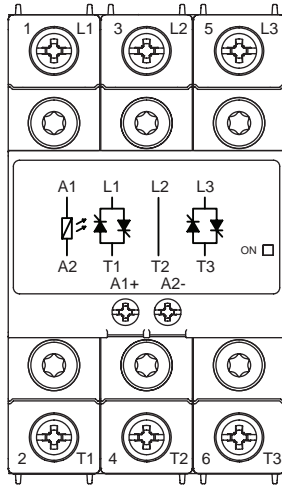

### Terminals labelling:

- 1/L1, 2/L2, 3/L3: Line connections
- 2/T1, 4/T2, 6/T3: Load connections
- A1(+): Positive control signal
- A2(-): Control ground

## Dimensions

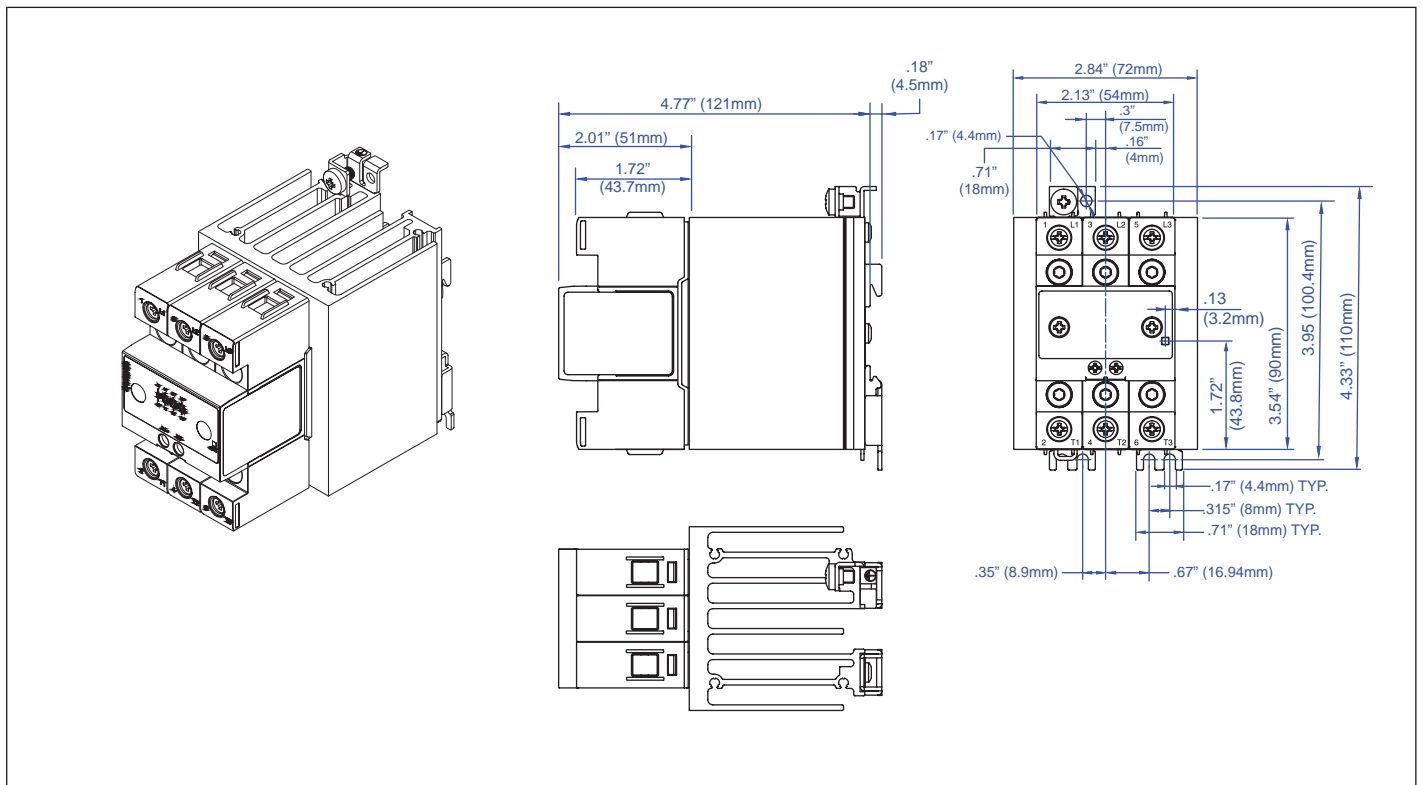

# MDI

## Connection Specifications

### Power Connections

1/L1, 3/L2, 5/L3, 2/T1, 4/T2, 6/T3

Use 75°C copper (Cu) conductors



2PSS60A40

Stripping length (X)

.47" (11 mm)

Connection type

M5 screw with box clamp

Rigid (solid & stranded)  
UL/cUL rated data

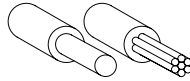

1x 2.5-25 mm<sup>2</sup>  
1x 14-3 AWG

Flexible  
With end sleeve

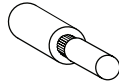

1x 2.5-16 mm<sup>2</sup>  
1x 14-6 AWG

Flexible  
With-out end sleeve

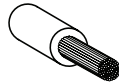

1x 4.0-25 mm<sup>2</sup>  
1x 12-3 AWG

Torque specification



Pozidriv 2  
UL: 2.5 Nm (22 lb-in)  
IEC: 2.0-2.5 Nm (17.7-22 lb-in)

Aperture for termination lug

n/a

Protective Earth (PE)  
connection

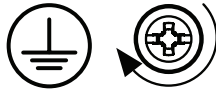

M5, 1.5Nm (13.3 lb-in)

Not provided with SSR. PE connection required when product is intended to be used in Class 1 applications according to EN/IEC 61140

### Control Connections

A1, A2

Use 75°C copper (Cu) conductors

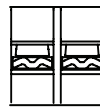

2PSS60A40

Stripping length (X)

.32" (8 mm)

Connection type

M4 screw with captivated washer

Rigid (solid & stranded)  
UL/cUL rated data

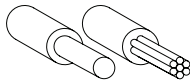

2x 0.5-2.5 mm<sup>2</sup>  
2x 18-12 AWG

Flexible  
With end sleeve

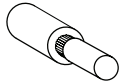

2x 0.5-2.5 mm<sup>2</sup>  
2x 18-12 AWG

Torque specification



Pozidriv 1  
UL: 0.5 Nm (4.4 lb-in)  
IEC: 0.4-0.5 Nm (3.5-4.4 lb-in)

## Connection Diagram

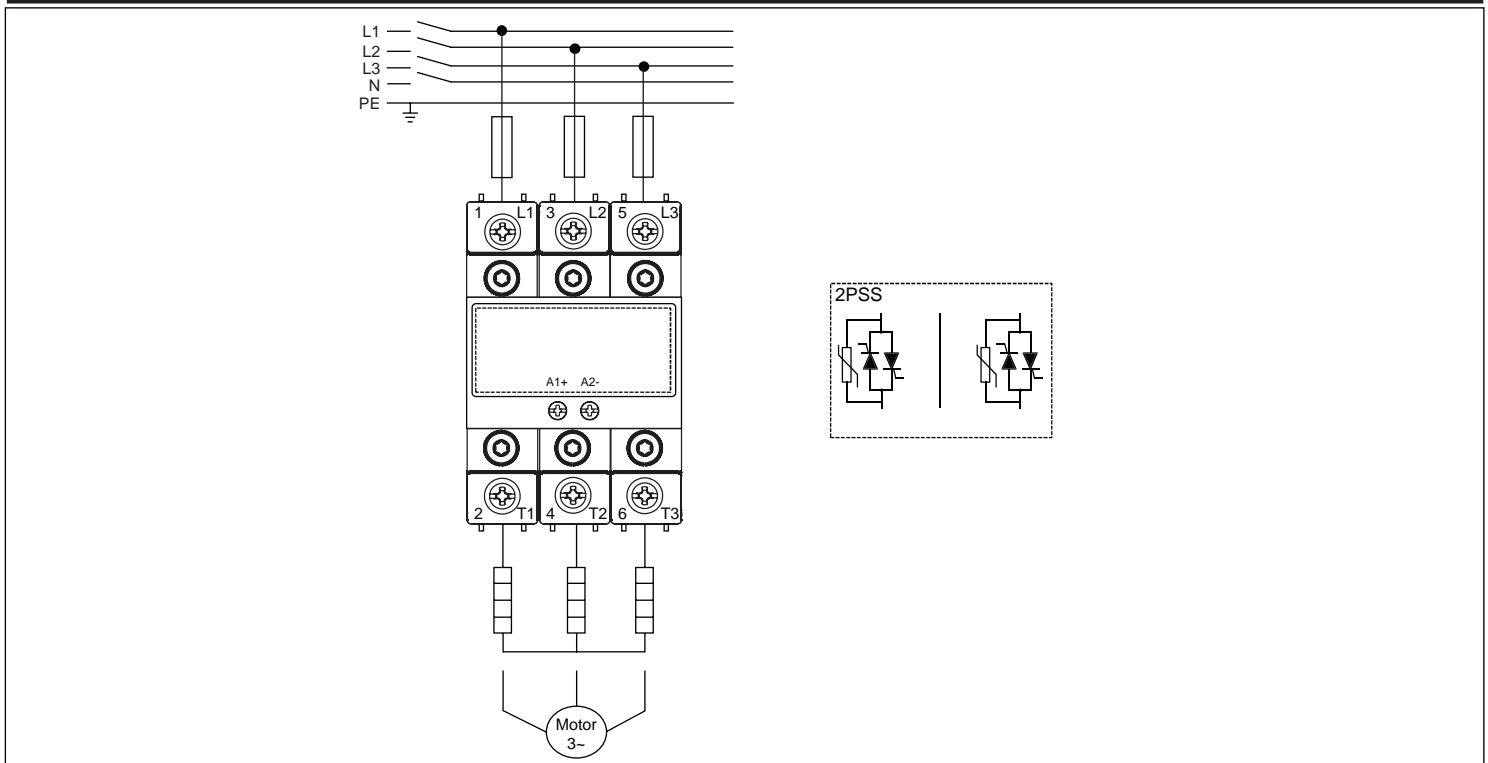

## Installation Instructions

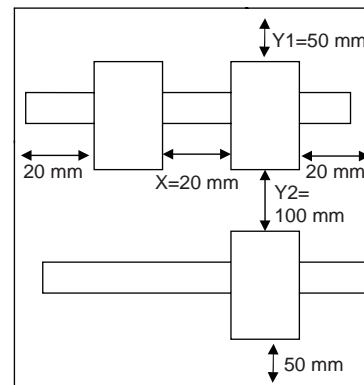
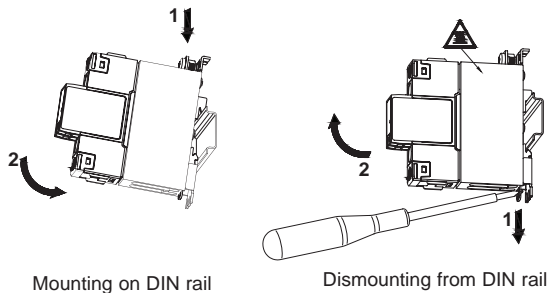

## Short Circuit Protection

### Protection Co-ordination, Type 1 vs Type 2:

Type one protection implies that after a short circuit, the device under test will no longer be in a functioning state. In type 2 co-ordination the device under test will still be functional after the short circuit. In both cases, however the short circuit has to be interrupted. The fuse between enclosure and supply shall not open. The door or cover of the enclosure shall not be blown open. There shall be no damage to conductors or terminals and the conductors shall not separate from terminals. There shall be no breakage or cracking of insulating bases to the extent that the integrity of the mounting of live parts is impaired. Discharge of parts or any risk of fire shall not occur.

The product variants listed in the table hereunder are suitable for use on a circuit capable of delivering not more than 100,000A ms Symmetrical Amperes. 600 Volts maximum when protected by fuses. Tests at 100,000A were performed with Class J fuses, fast acting; please refer to the tables below for maximum.

### Co-ordination type 1 (UL 508)

Part No.	Max. fuse size [A]	Class	Short circuit current [kArms]	Voltage [VAC]
2PSS60A40	40	J	100	Max. 600