

OPERATING INSTRUCTIONS

1/25/01

OSRAM
SYLVANIA
Process Heat

SERPENTINE II, VI HOT AIR TOOLS

SERPENTINE II HOUSING 029763
SERPENTINE II ELEMENTS 029765, 029766, 029767, 060418

SERPENTINE VI HOUSING 057088
SERPENTINE VI ELEMENTS 040291, 040292, 061429, 056548



*Handle not available

⇒ FOR SAFETY AND LONG HEATER LIFE, CAREFULLY READ THIS MANUAL BEFORE USE.

Description

Compact and efficient process air/inert gas heater, capable of producing exit temperatures up to 1400°F (760°C) with standard elements, and up to 1500°F with the “Two-Stage” elements. The heater unit consists of two parts - a replaceable serpentine-coil electric heater element, which fits into a stainless steel “triple-pass” exchanger housing. This special housing uses the incoming air to cool the outer shell prior to passing through the heater element. This not only minimizes radiant heat losses but provides a cool outer shell, to minimize burn injury for operators who accidentally contact the heater. Two heater sizes are available; the Serpentine II (wattages from 2000 to 3600W) and the Serpentine VI (wattages from 5000 to 8000W). If operated correctly, element life will be greater than 5000 hours.

Specifications

SERPENTINE II ELEMENTS (used with housing 029763)

PART NUMBER	MAX WATTS	MAX VOLTS	MAX AMPS	MAX PRESSURE (PSI)	LENGTH “A”	OD “B”
029765	2000	240	8.3	25	8.20” (208mm)	0.63” (16mm)
029766	2800	240	11.7	25	8.20” (208mm)	0.63” (16mm)
029767	3600	240	15	25	8.20” (208mm)	0.63” (16mm)
060418	3600 (two-stage)	240	15	25	8.20” (208mm)	0.63” (16mm)

OPERATING INSTRUCTIONS

1/25/01

**OSRAM
SYLVANIA**
Process Heat

SERPENTINE VI ELEMENTS (Used with housing 057088)

PART NUMBER	MAX WATTS	MAX VOLTS	MAX AMPS	MAX PRESSURE (PSI)	LENGTH "A"	OD "B"
040291	5000	240	20.8	25	10.88" (276mm)	1.25" (32mm)
040292	6000	240	25	25	10.88" (276mm)	1.25" (32mm)
061429	6000 (two- stage)	240	25	25	10.88" (276mm)	1.25" (32mm)
056548	8000	240	33.3	25	10.88" (276mm)	1.25" (32mm)

HOUSING ASSEMBLIES

PART NUMBER	SERPENTINE TYPE	"A"	"B"	"C"	"D"	"E"
029763	SERP II	1.6" (40mm)	9.0" (229mm)	10.0" (254mm)	0.7" (18mm)	3 / 8" NPT
057088	SERP VI	2.1" (54mm)	11.9" (302mm)	12.9" (327mm)	1.4" (35mm)	3 / 4" NPT

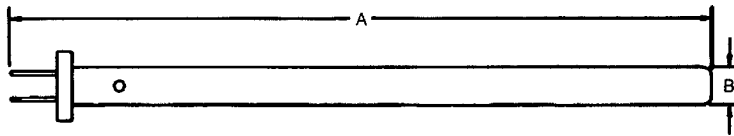

ELEMENT

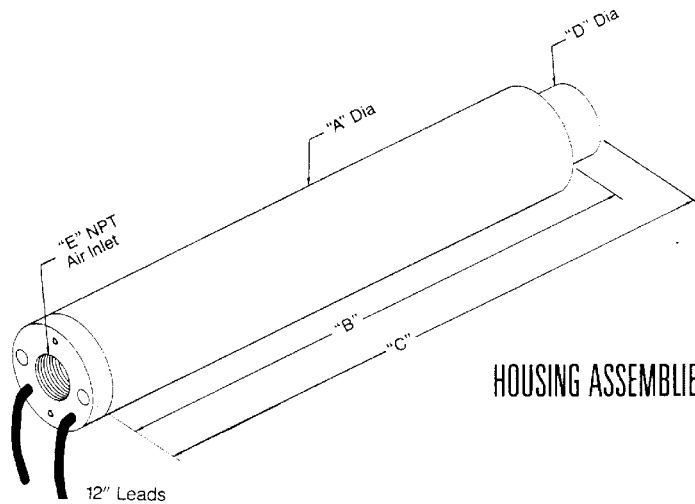

HOUSING

HOUSING ASSEMBLIES

Safety

- ❑ **SHOCK HAZARD** Only qualified individuals should install this heater and related controls. Follow all applicable electrical codes and use proper wiring.
- ❑ **BURN/FIRE/EXPLOSION HAZARD** Do not use with or near explosive or reactive gases. Avoid contact with the side, or exposure to the exit-end, during or soon after operation. **DO NOT USE NEAR VOLATILE OR COMBUSTIBLE MATERIALS.**

Precautions

- ❑ Use filtered air. Avoid grease, oil, or oil vapors, corrosive or reactive gases which will damage heater.
- ❑ Operate at safe voltages as shown on the PERFORMANCE CURVES. Excess voltage will cause premature failure.
- ❑ Always have sufficient airflow through the heater before applying power. Otherwise element will overheat very quickly, and burn out. **NOTE:** A thermocouple cannot detect temperatures if there is no flow – turn on flow before applying power, even when a controller with a thermocouple is being used.
- ❑ Use phase angle fired power controllers. On-off controllers may shorten heater life (or burnout element).
- ❑ For closed-loop control, use exposed junction type “K” thermocouple within one inch of the heater exit.
- ❑ For closed-loop control, use a temperature controller with a fast sampling period (500ms) and minimal overshoot.

Installation

- Securely mount the heater.
- Connect the filtered air source to the heater.
- If a thermocouple is used, ensure that it is located within one inch from the heater exit.

Start-up

- Reference the PERFORMANCE CURVES section for operational parameters before attempting to operate heater(s).
- Turn on air supply and adjust to desired flow/pressure.
- If using a closed loop system, turn on power to the temperature and power controller, then set the desired temperature on the temperature controller. If using an open loop system, increase power to the heater through the power controller until the desired temperature is attained.

Performance Curves

The attached performance curves show exit air temperatures at different airflows and voltages. Pressure readings (longer dashed lines) are measured at the inlet to the heater with no entrance or exit restrictions. Solid lines indicate safe, normal-life operating conditions. The shorter dash lines indicate marginal, shorter-life operating conditions leading to premature burnout. With a known flow (or pressure) at the heater entrance, follow the flow (or pressure) line across until it meets the desired temperature curve. Drop a line straight down to intersect the x-axis. This point, along the “Heater volts – true RMS” axis, represents the voltage required to generate the desired exit air temperature at the chosen flow rate (inlet pressure).

Serpentine II Housing 029763 With Heater Cartridge 029765

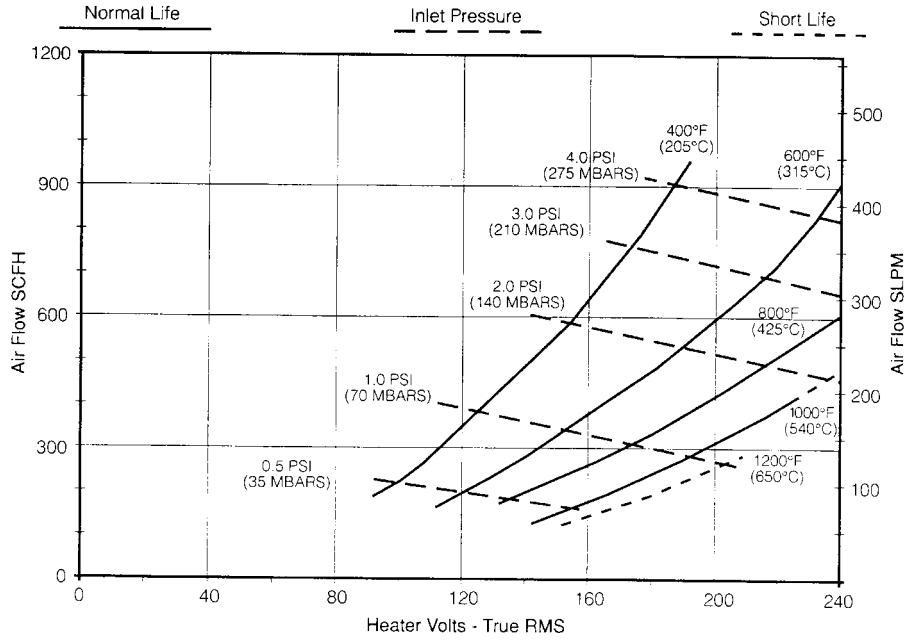

Serpentine II Housing 029763 With Heater Cartridge 029766

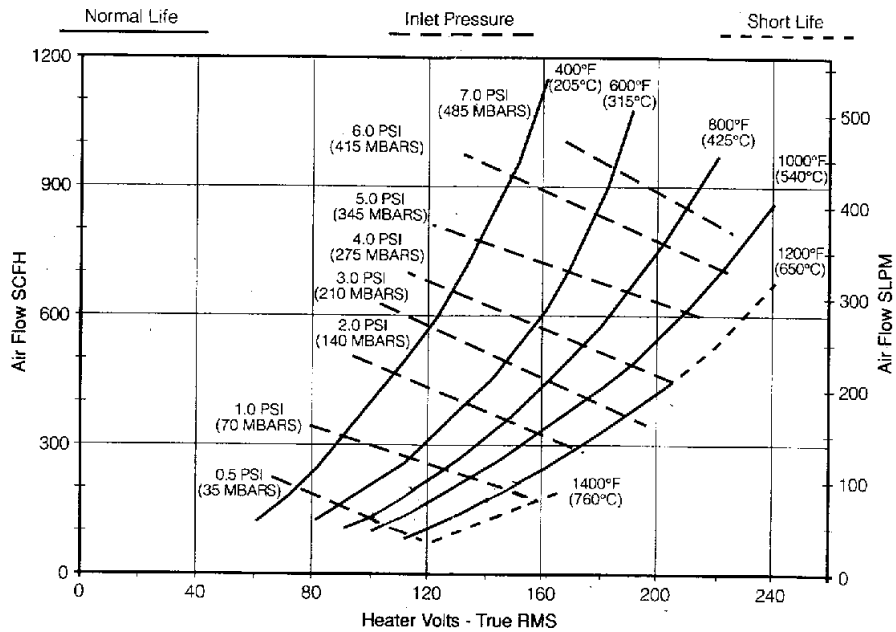

Serpentine II Housing 029763 With Heater Cartridge 029767

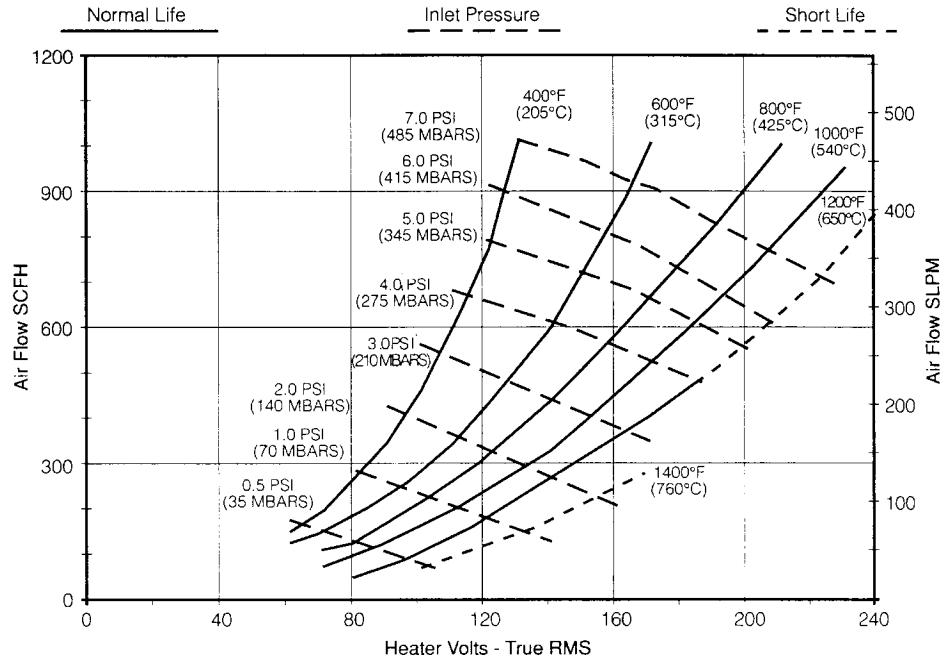

Serpentine II Housing 029763 With Heater Cartridge 060418 (2-stage)

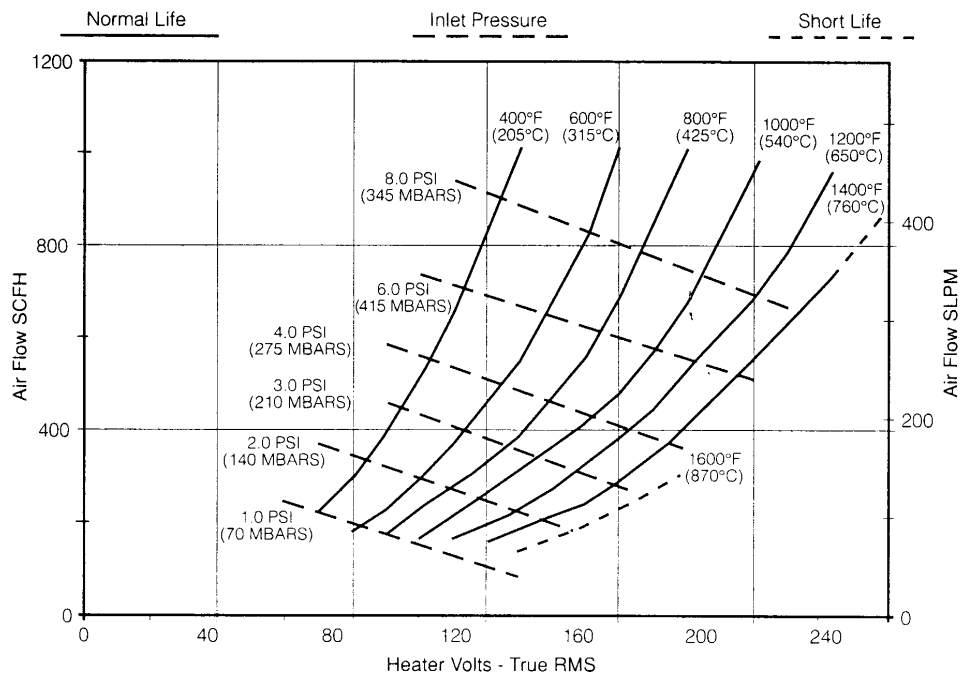

OPERATING INSTRUCTIONS

1/25/01

**OSRAM
SYLVANIA**
Process Heat

Serpentine VI Housing 057088 With Heater Cartridge 040291

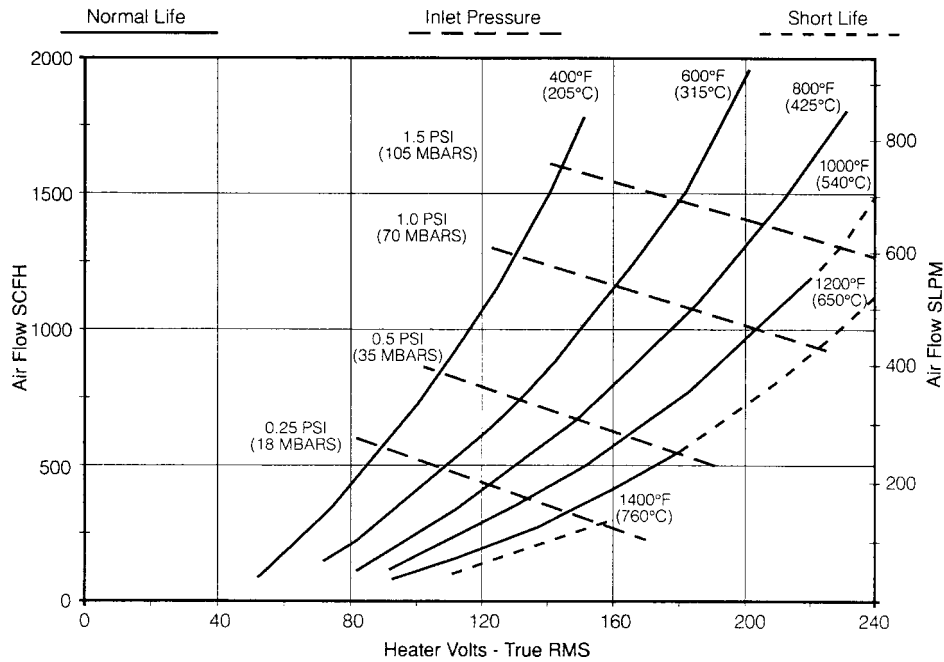

Serpentine VI Housing 057088 With Heater Cartridge 040292

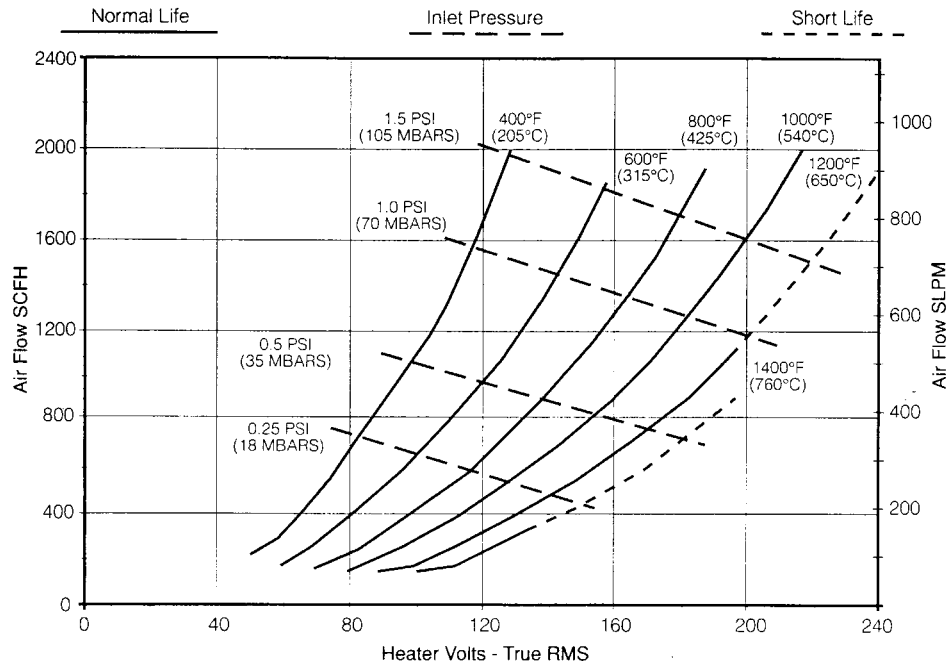

Serpentine VI Housing 057088 With Heater Cartridge 061429 (2-stage)

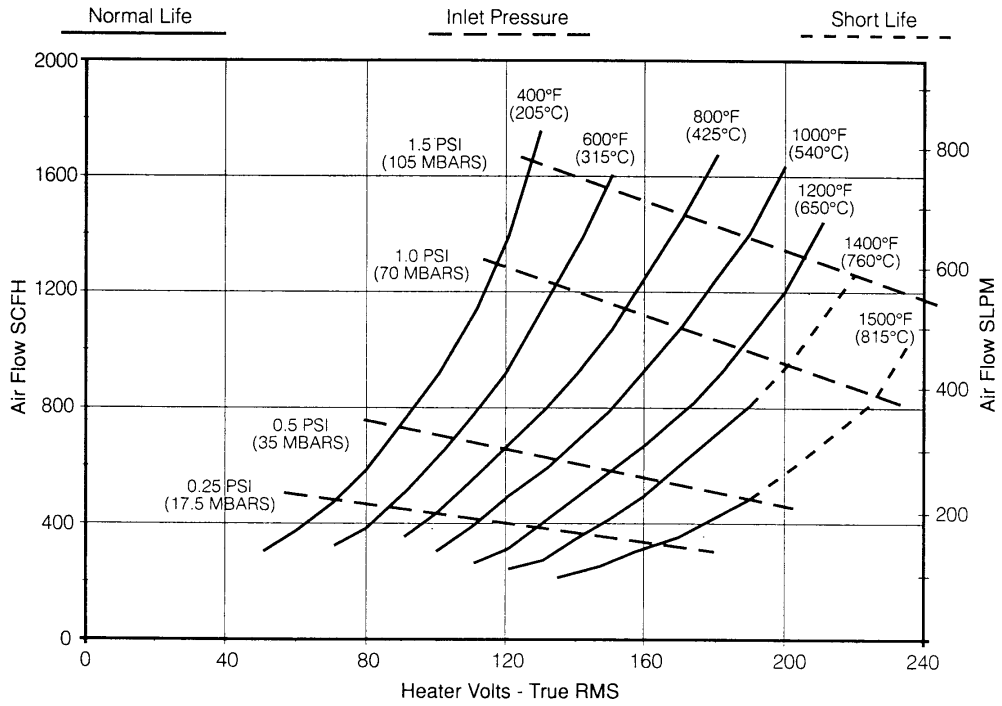

Warranty

OSRAM SYLVANIA warrants that all products to be delivered hereunder will be free from defects in material and workmanship at the time of delivery. OSRAM SYLVANIA's obligation under this warranty shall be limited to (at its option) repairing, replacing, or granting a credit at the prices invoiced at the time of shipment for any of said products. This warranty shall not apply to any such products which shall have been repaired or altered, except by OSRAM SYLVANIA, or which shall have been subjected. OSRAM SYLVANIA shall be liable under this warranty only if (A) OSRAM SYLVANIA receives notice of the alleged defect within sixty (60) days after the date of shipment; (B) the adjustment procedure hereinafter provided is followed, and (C) such products are, to OSRAM SYLVANIA's satisfaction, determined to be defective.

THE WARRANTY SET FORTH IN THE PRECEDING PARAGRAPH IS EXCLUSIVE AND IN LIEU OF ALL OTHER WARRANTIES, EXPRESS OR IMPLIED, INCLUDING, WITHOUT LIMITATION, ANY IMPLIED WARRANTY OF FITNESS FOR A PARTICULAR PURPOSE OR OF MERCHANTABILITY.

The information contained in this manual is based on data considered to be true and accurate. Reasonable precautions for accuracy has been taken in the preparation of this manual, however OSRAM SYLVANIA assumes no responsibility for any omissions or errors, nor assumes any liability for damages that may result from the use of the product in accordance with the information contained in this manual.

Please direct all warranty/repair requests or inquiries to the place of purchase, and provide the following information, in writing:

- (A) Order number under which products were shipped
- (B) Model/Serial Number of product
- (C) Reason for rejection

PRODUCTS CAN NOT BE RETURNED TO OSRAM SYLVANIA WITHOUT AUTHORIZATION.

Replacement, repair, or credit for products found to be defective will be made by the place of purchase. All products found to be not defective will be returned to the Buyer; transportation charges collect or stored at Buyers expense.